

**Tork Xpressnap® Fit™
Counter Napkin Dispenser**

Signature
Design

**Distributeur de Serviettes de
Comtoir Tork Xpressnap® Fit™**

**Dispensador de Servilletas para
Mostrador Tork Xpressnap® Fit™**

N14

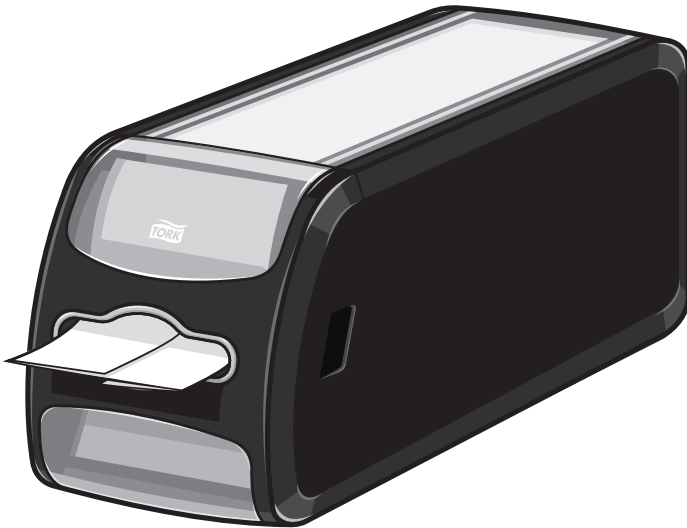

Tork Xpressnap® Fit™ Counter Napkin Dispenser

1

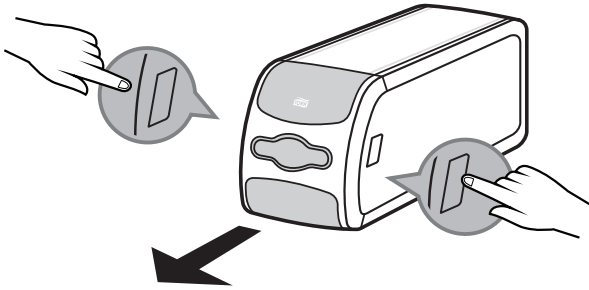

2

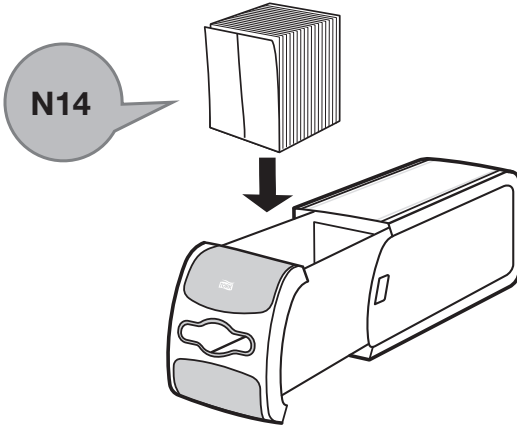

3

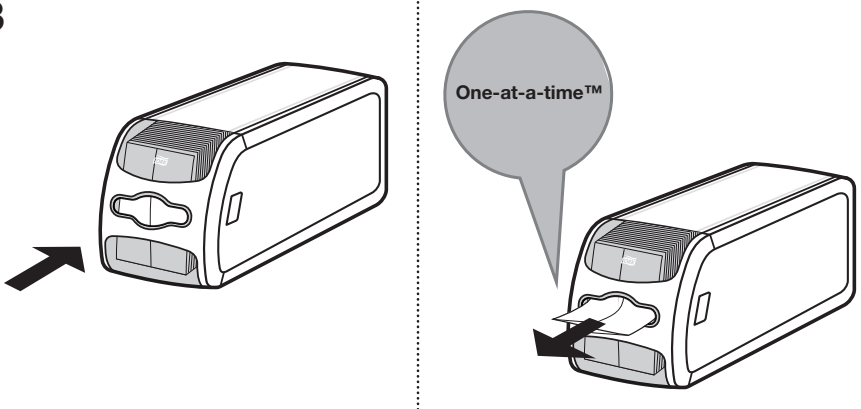

1

AD-a-Glance™

TEMPLATES/
MODÈLES/
PLANTILLAS

adaglance.torkglobal.com

74 x 224 mm

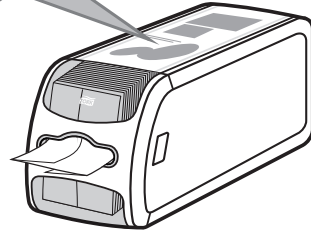

2

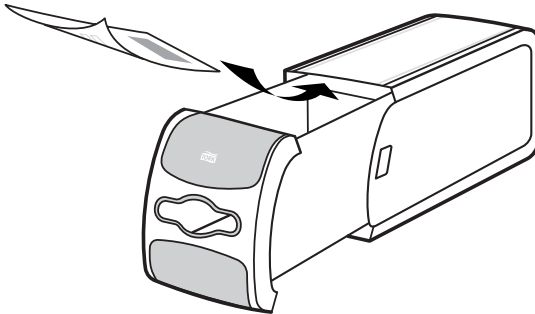

3

AD-a-Glance™

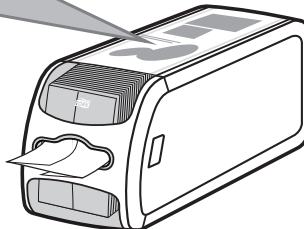



<https://www.torkglobal.com/iv/n14/na/fit-counter-s/>

EN Cleaning instructions

- Use mild cleaners. Wipe with cloth using soap and water. Do not use abrasives. Dispenser is not dishwasher safe.

FR Instructions de nettoyage

- Utiliser des nettoyeurs non agressifs. Nettoyer avec chiffon, de l'eau et du savon. Ne pas utiliser d'agents abrasifs. Le distributeur n'est pas conçu pour au lave-vaisselle.

ES Instrucciones de limpieza

- Utilice detergentes suaves. Frote con un paño humedecido con agua y jabón. No use abrasivos! Este dispensador no se debe lavar en máquinas lavavajillas.



essity

Manufactured for
Essity Professional Hygiene North America LLC
Philadelphia, PA 19104
www.essity.com, www.torkusa.com
Made in United States
Patents/Brevets/Patentes: www.essity.com/patents